



THE ONE SHOW



GENERAL SPECIFICATIONS

Type	Floodlights for suspension lighting	
Application	Industrial / Commercial	
System	12-16-46 LED	
STREETLIGHT DATA		
Diameter of reflector	620 mm	
Maximum weight	14,80 kg	

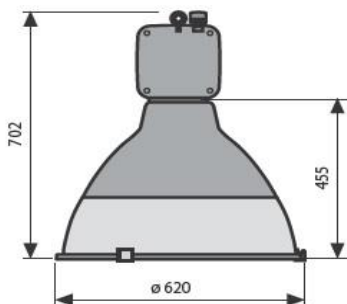

TECHNICAL SPECIFICATIONS

Insulation class	CL I
Color temperature (from/to)	4000K / 5500K
Power correction factor	> 0,9
Overall protection degree	IP66
Protection degree against external impacts	IK08
Certifications	CE
	All the electric components are ENEC certified.
Construction standards	EN 60598-1, EN 60598-2-5
Class of photobiological risk	Risk group exempt from this according to EN 62471

POWER SUPPLY SPECIFICATIONS

Led current - from/to:	600mA / 1000mA
Power supply	220 - 240V / 50 - 60 Hz VAC
Driver	high efficiency electronic power source and duration, intended for external use.
Knife switch	included, to interrupt the power supply at the device's opening.
Cable plate	complete with easily replaceable electronic unit.
Power supply cable access	through a PG 13.5 cable gland (IP68).

PROTECTION AGAINST SURGES

All versions are protected against overloads and surges to protect components and LEDs.	
CL I:	up to 6kV

MAINTAINED AVERAGE LUMINOUS FLUX

LED CURRENT	TYPE OF LED	L80** (hr)	L70** (hr)
700 mA	LUXEON M	> 70000	> 80000
1000 mA	XM-L 2	> 70000	> 80000

** L80 = the unit keeps the 80% of the initial light flux after the number of hours indicated in above table.

** L70 = the unit keeps the 70% of the initial light flux after the number of hours indicated in above table.

For higher Ta, please don't hesitate to consult FAEL headquarter/distributors.



MOUNTING SPECIFICATIONS	
Installation	with suspension eyebolt
Installation height	5 ÷ 24 m
These devices should not be installed above sources of heat.	

MATERIALS AND FITTINGS	
LED	First brand Led (Multichip Philips Luxeon M o CREE XM-L 2) mounted on a pressed aluminum circuit, highly heat-dissipating MCPCB (Metal Core Printed Circuit Board).
Body	in die-cast recyclable aluminium alloy with wide cooling fins.
Semi-refractor	of highly aesthetic aspect, in aluminium coated in Silver color.
Band	in thermoplastic material of 309 mm height.
Paint	silver-colored polyester powders (RAL 9006).
Glass	extra-clear tempered glass, 4mm thick.
Gaskets	anti-aging rubber
Pressure compensation filter	teflon
External screw	in stainless steel

OPTICAL SYSTEM	
Description	The optic consists of high efficiency metallized polycarbonate vacuum reflectors.
Optic group	including reflectors, easily replaceable.
Ottica tipo	ROTOSIMMETRIC
Fasci luminosi	Optic A: for installation height from 5 to 12 m. Optic B: for installation height from 6 to 15 m. Optic C: for installation height from 6 to 24 m. and especially for the lighting of corridors between shelving units.

PHOTOMETRIC DATA

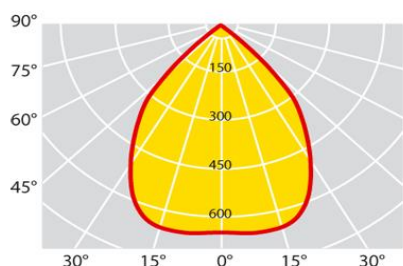

THE ONE SHOW - LED LUXEON M



OPTIK A

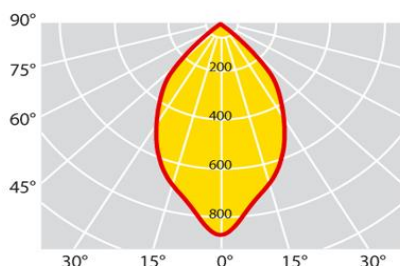

THE ONE SHOW - LED LUXEON M



OPTIK B

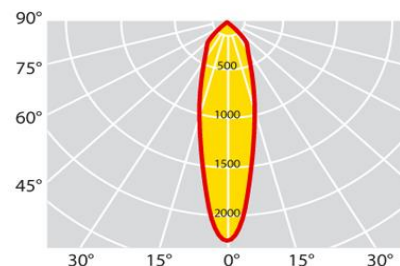

THE ONE SHOW - LED LUXEON M



OPTIK C

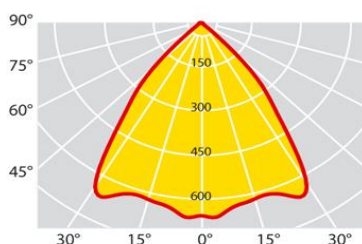

THE ONE SHOW - LED XM-L 2



OPTIK A

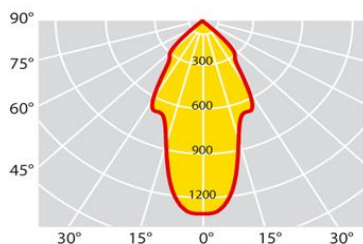

THE ONE SHOW - LED XM-L 2



OPTIK B

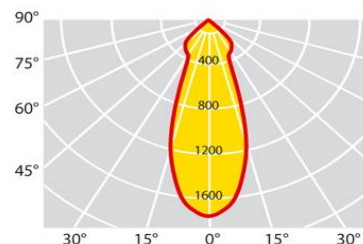

THE ONE SHOW - LED XM-L 2



OPTIK C

The Fael LUCE products are subject to constant evolution. Therefore, the values given in this document are subject to change.

